

ARE YOU READY FOR

SUMMER

CAMP 2026

KUALA LUMPUR, MALAYSIA

EMS

LANGUAGE CENTRE

ENGLISH MADE SIMPLE



JUNE - JULY - AUGUST

ABOUT EMS & Summer Camp

Every summer, EMS Language Centre welcomes students from around the world, creating a truly international environment where students practice English naturally, gain confidence, and build friendships across cultures.

With over 15 years of experience, our Summer Camp program is designed for children (ages 6–13), teenagers, and young adults (14+). Classes run 5 days a week, Monday to Friday, and include 4 hours of Intensive General English and 2 hours of Extra Learning Activities. This learner-centered approach helps students improve all language skills while developing teamwork and social competence.

Located in the city center of Kuala Lumpur, near the Petronas Towers, EMS offers a modern learning environment with 37 fully equipped classrooms for adults and 10 dedicated classrooms for children, supported by a team of professional international teachers.

Upon arrival, each student takes a placement test and is placed into one of 12 English levels, ensuring personalized learning. Over one month of intensive study, students typically progress by half an English proficiency level.

As an international English school with 15 years of experience, EMS provides complete support throughout the students' stay in Malaysia, including accommodation, daily lunch, transportation for all scheduled trips, and on-site supervision during excursions.



TRIPS & Activities



Malaysia's most popular theme park with over 80 attractions for all ages.

SUNWAY LAGOON WATER PARK

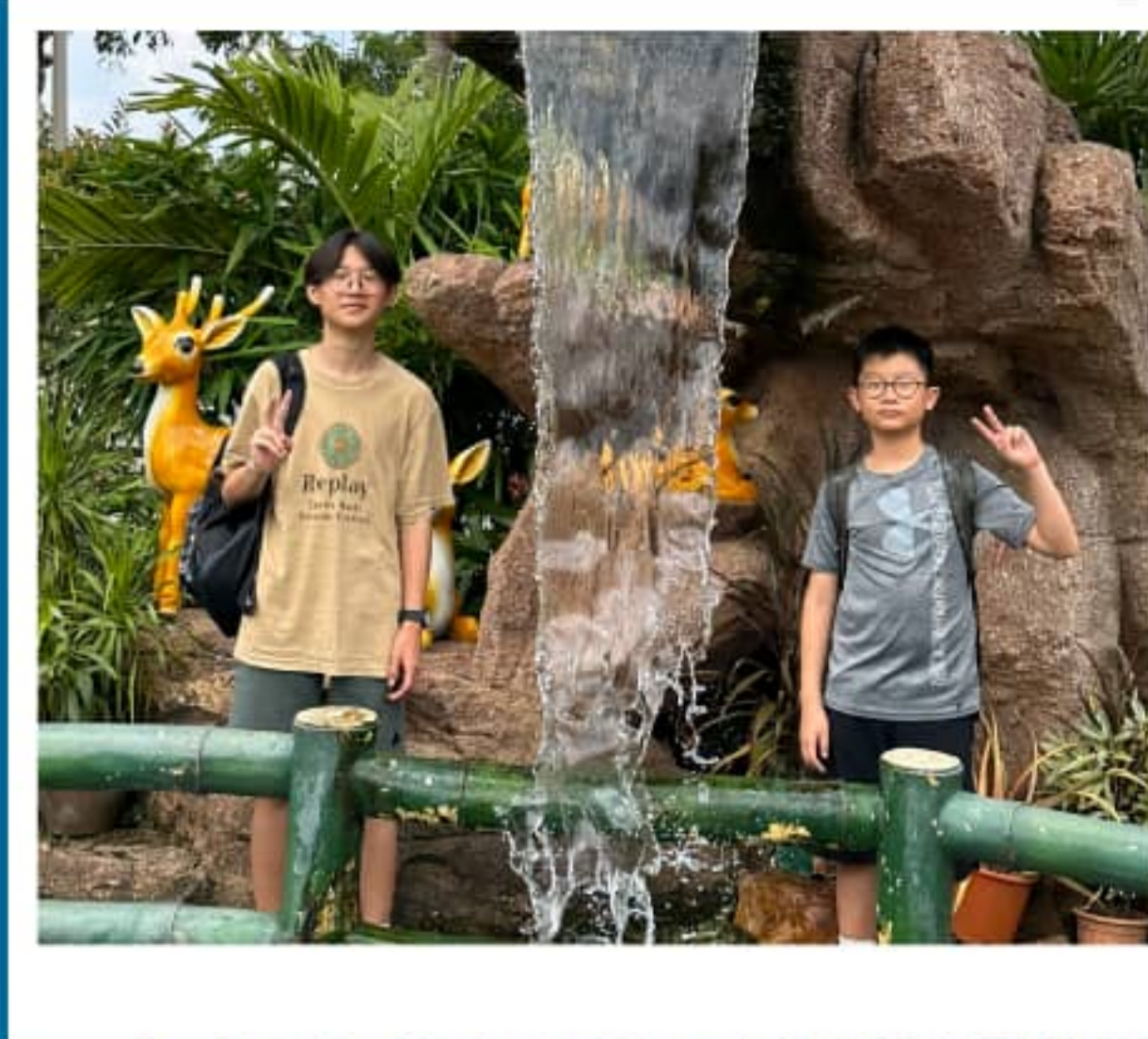

Visit Kuala Lumpur's iconic landmarks, including Batu Caves, Merdeka Square, and major cultural sites.

CITY TOUR & BATU CAVES

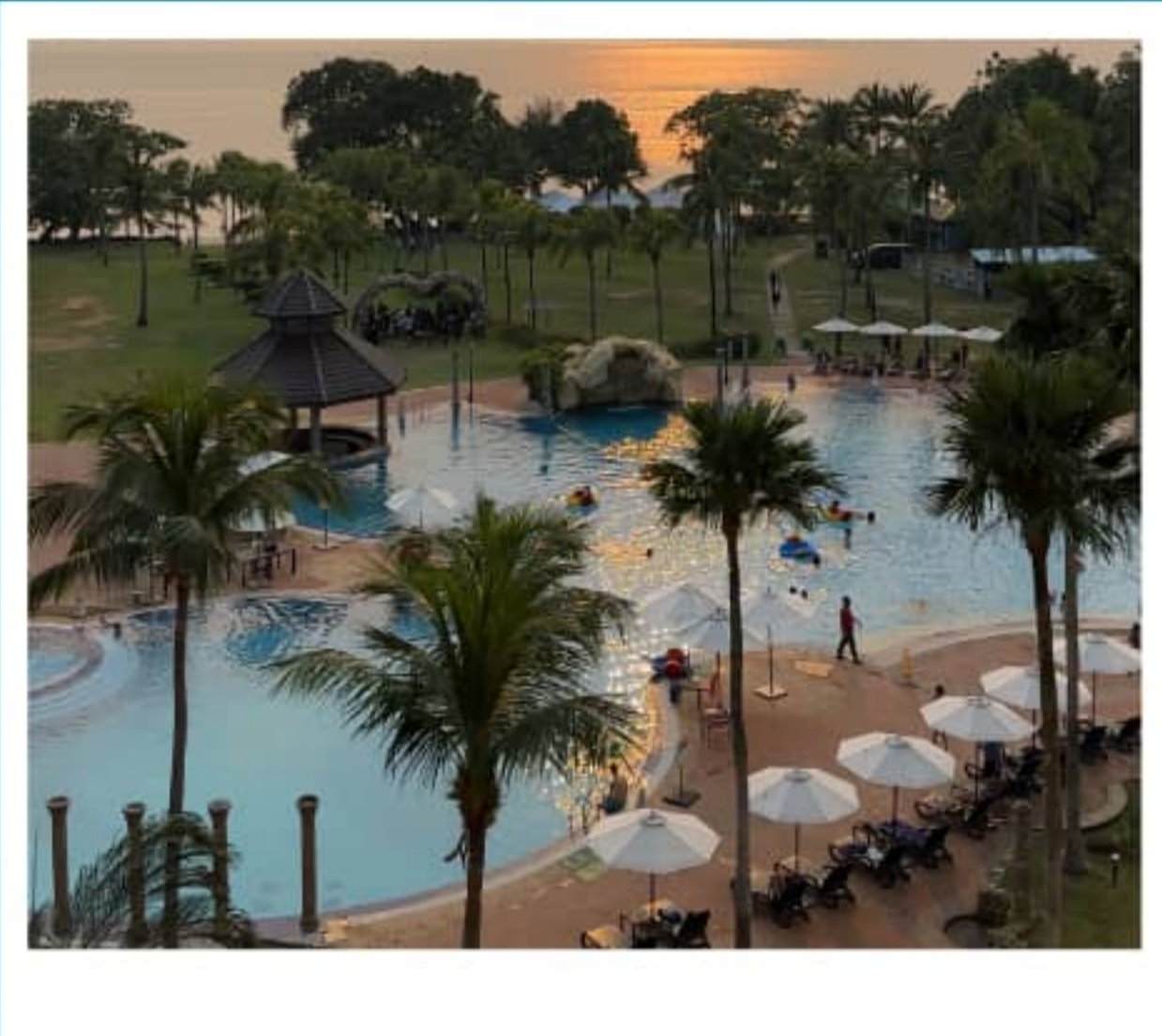

A relaxing beach getaway with resort stay, water activities, lunch, and breakfast included.

PORT DICKSON (2D/1N)

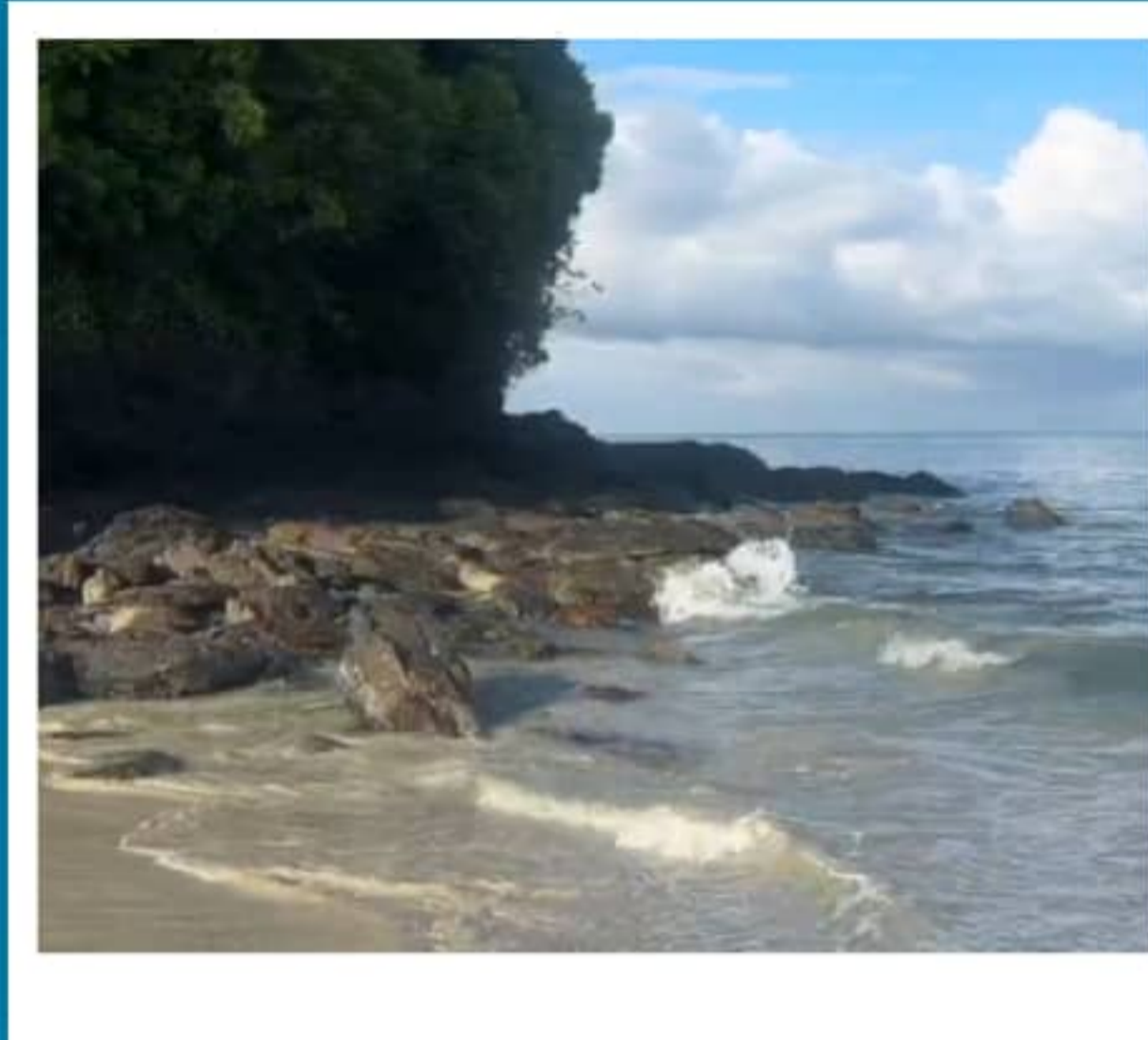

A tropical island escape including round trip flight, hotel stay, beach activities, and sightseeing.

LANGKAWI ISLAND (3D/2N + FLIGHT)



Enjoy cable car rides, cool mountain weather, shopping outlets, and scenic views.

GENTING HIGHLANDS



SPORT NIGHT



MOVIE NIGHT

EVENING & CAMPUS ACTIVITIES



CULTURE NIGHT



GRADUATION CEREMONY

SUMMER CAMP

Schedule

INTENSIVE GENERAL ENGLISH (IGE) 4 hours / day

EXTRA LEARNING ACTIVITIES (ELA) 2 hours / day

MONTHLY INTAKES AVAILABLE IN

JUNE, JULY, AUGUST

JUNE	MON	TUE	WED	THU	FRI	SAT	SUN
	1	2 Arrival Day	3 Start Date	4	5	6 Sunway Lagoon	7 City Tour & Batu Caves
	8	9	10 Movie Night	11	12	13 Port Dickson Trip	14 Port Dickson Trip
	15	16	17 Sport Day	18	19 Langkawi Trip	20 Langkawi Trip	21 Langkawi Trip
	22	23	24 Culture Night	25	26	27 Genting Highlands	28 Free Day
	29 Final Exam + Graduation	30 Safe Flight Back Home					

JULY	MON	TUE	WED	THU	FRI	SAT	SUN
			1	2 Arrival Day	3 Start Date	4 Sunway Lagoon	5 City Tour & Batu Caves
	6	7	8 Culture Night	9	10	11 Port Dickson Trip	12 Port Dickson Trip
	13	14	15 Sport Night	16	17 Langkawi Trip	18 Langkawi Trip	19 Langkawi Trip
	20	21	22 Movie Night	23	24	25 Genting Highlands	26 Free Day
	27	28 Final Exam + Graduation	29 Safe Flight Back Home	30	31		

AUGUST	MON	TUE	WED	THU	FRI	SAT	SUN
				30 July Arrival Day	31 July Start Date	1 Sunway Lagoon	2 City Tour & Batu Caves
	3	4	5 Culture Night	6	7	8 Port Dickson Trip	9 Port Dickson Trip
	10	11	12 Sport Night	13	14 Langkawi Trip	15 Langkawi Trip	16 Langkawi Trip
	17	18	19 Movie Night	20	21	22 Genting Highlands	23 Free Day
	24	25 Free Day	26 Final Exam + Graduation	27 Safe Flight Back Home	28	29	30

WHICH PACKAGE

Should I Choose?

		ECONOMY-SAVER PACKAGE	BRONZE PACKAGE	SILVER PACKAGE	GOLD PACKAGE	PLATINUM PACKAGE
COURSE	Intensive General English (IGE)	✓	✓	✓	✓	✓
	Extra Learning Activities (ELA)	✓	✓	✓	✓	✓
	Registration Fee	✓	✓	✓	✓	✓
	Study Materials	✓	✓	✓	✓	✓
	Lunch	✗	✓	✓	✓	✓
	Airport Transfer (2 Ways)	✗	✓	✓	✓	✓
EXTRAS	EMS T-Shirt	✓	✓	✓	✓	✓
	SIM Card + Internet	✓	✓	✓	✓	✓
	Certificate of Completion	✓	✓	✓	✓	✓
ACCOMMODATION	Small Room	✓	✗	✓		
	Middle Room	May Choose Upon Request	✗		✓	
	Master Room		✗			✓
City Tour & Batu Caves						
TRIPS & ACTIVITIES	Sunway Lagoon					
	Langkawi Island (3D/2N)					
	Genting Highlands					
	Port Dickson (2D/1N)	✗	✓	✓	✓	✓
	Sport Night					
	Movie Night					
	Culture Night					
	Insurance	✗	✓	✓	✓	✓
	Graduation Ceremony	✗	✓	✓	✓	✓

GUARDIAN PLATINUM

- › Airport Transport
- › Accommodation
- › City Tour & Batu Caves
- › Sunway Lagoon
- › Langkawi Island
- › Genting Highlands
- › Port Dickson
- › Sport Night
- › Movie Night
- › Book Club Night
- › Culture Night
- › EMS T-shirt + Cap
- › SIM Card + Internet
- › Graduation Ceremony
- › Airport Transportation (Include in Child's Package)

GUARDIAN BRONZE

- › Airport Transport
- › City Tour & Batu Caves
- › Sunway Lagoon
- › Langkawi Island
- › Genting Highlands
- › Port Dickson
- › Sport Night
- › Movie Night
- › Book Club Night
- › Culture Night
- › EMS T-shirt + Cap
- › SIM Card + Internet
- › Graduation Ceremony
- › Airport Transportation (Include in Child's Package)



SUMMER CAMP

Package & Price List 2026

SUMMER CAMP PACKAGE 2026	TOTAL PRICE (MYR)	DEPOSIT (MYR)
Economy / Saver	5,600/6,100/7,200	1,000
Bronze Package	8,500	1,000
Silver Package	10,000	1,000
Gold Package	10,500	1,000
Platinum Package	11,600	1,000

GUARDIAN PACKAGE 2026	TOTAL PRICE (MYR)	DEPOSIT (MYR)
Guardian Silver (No Accommodation)	3,000	1,000
Guardian Gold	4,000	1,000



ACCOMMODATION

Details

EMS accommodation offers 3-4 bedroom apartments with facilities including:



Swimming Pool

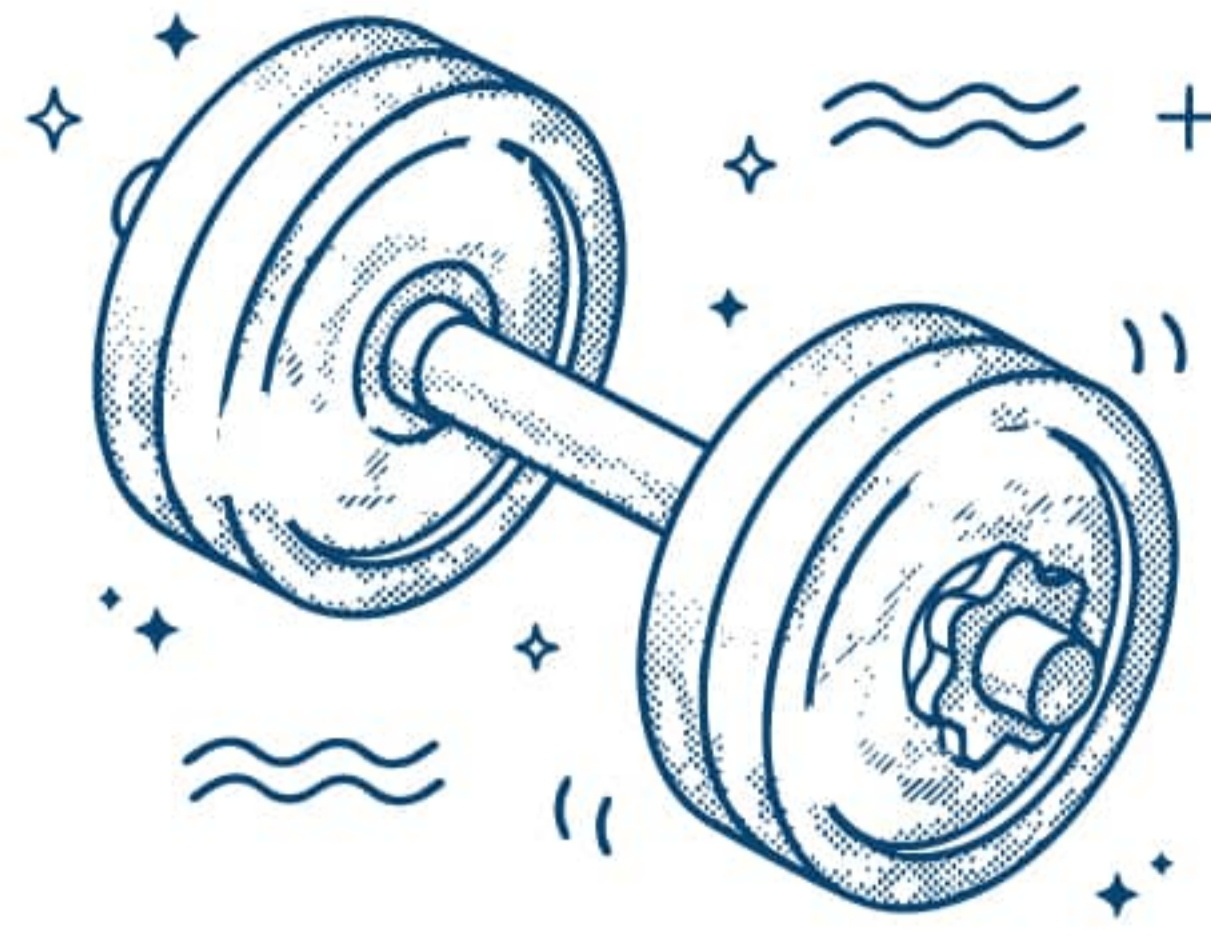

Gymnasium

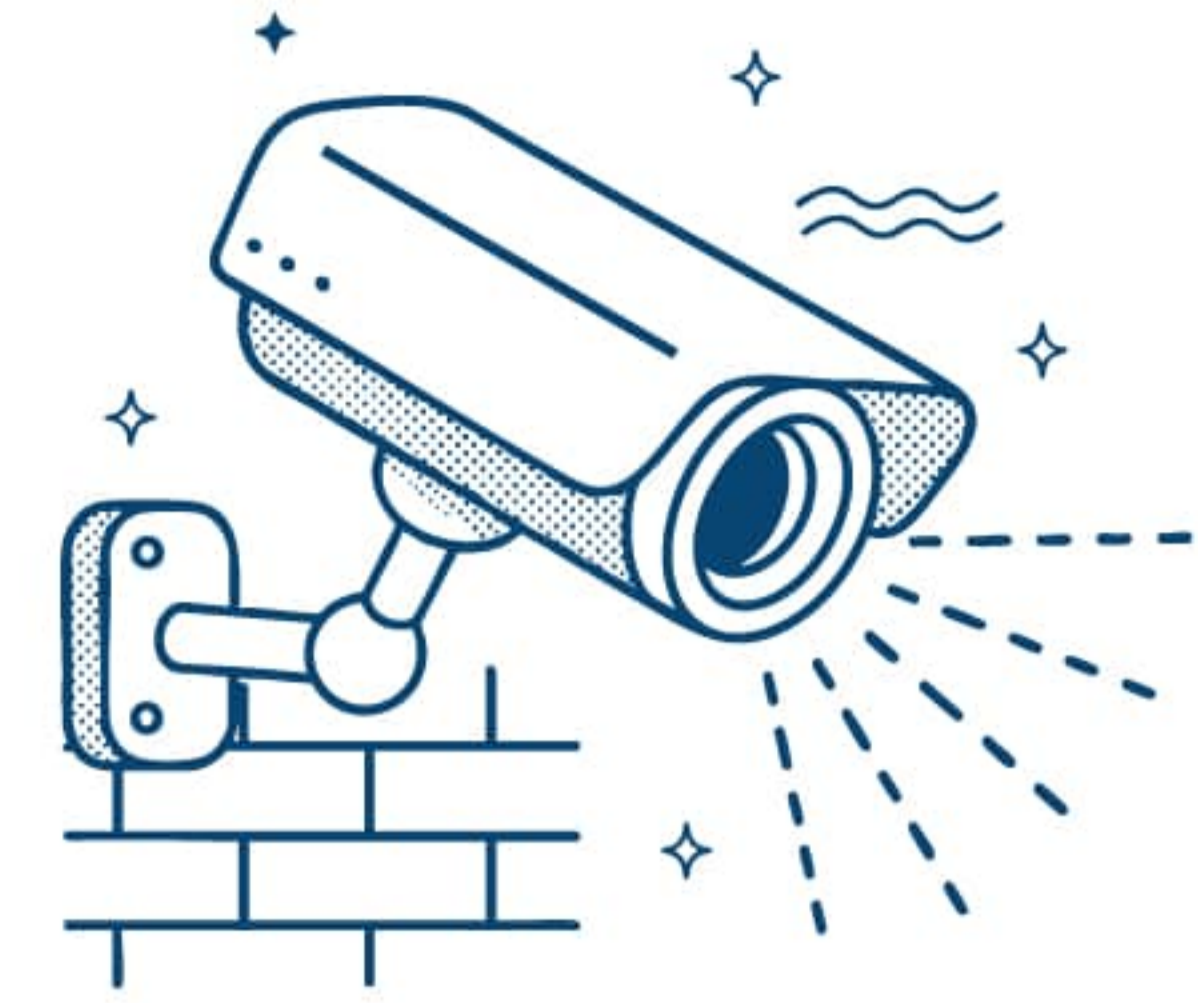

24-Hour Security

Room Options :

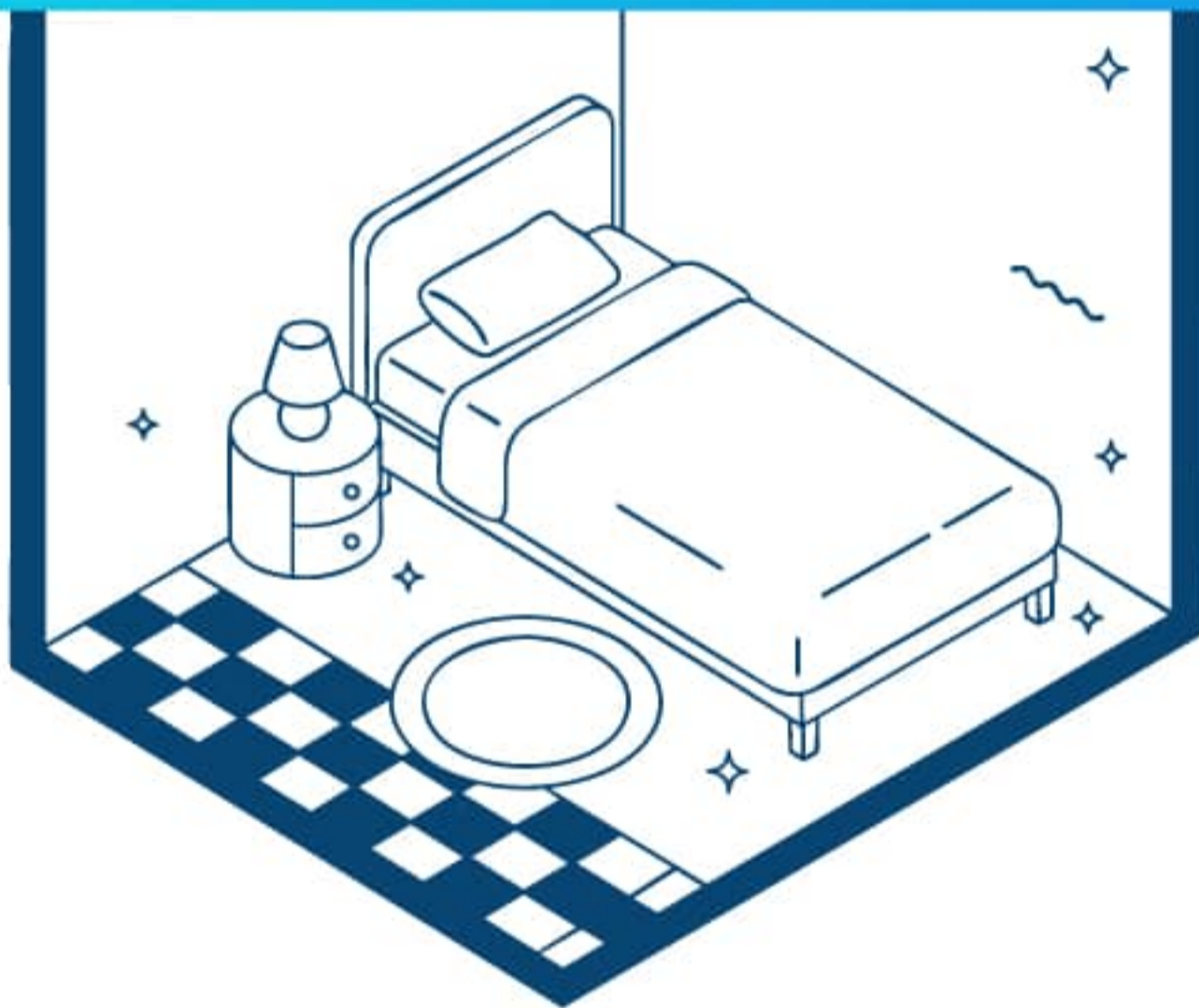

Small Room

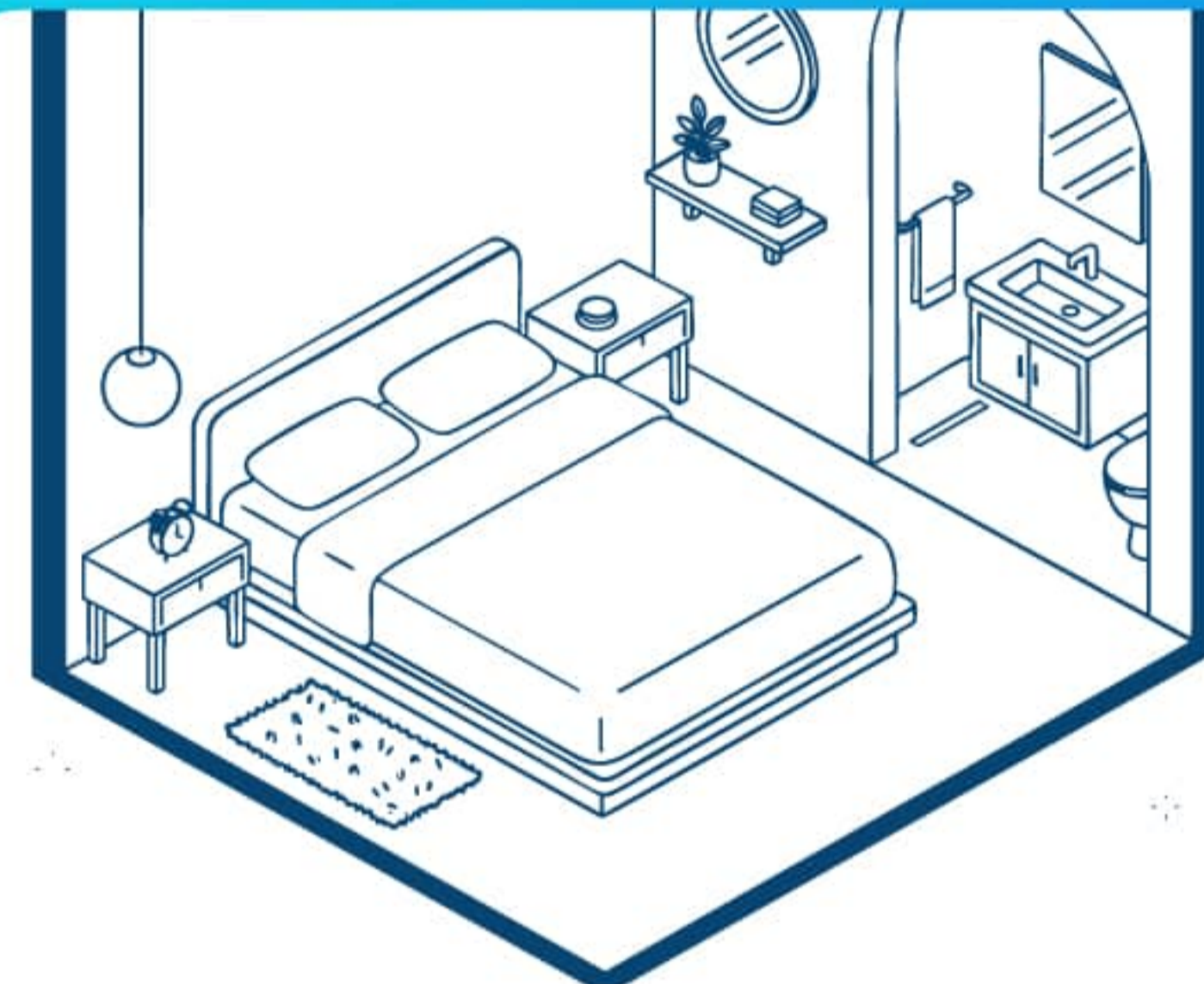

**Master Room
(Private Bathroom)**

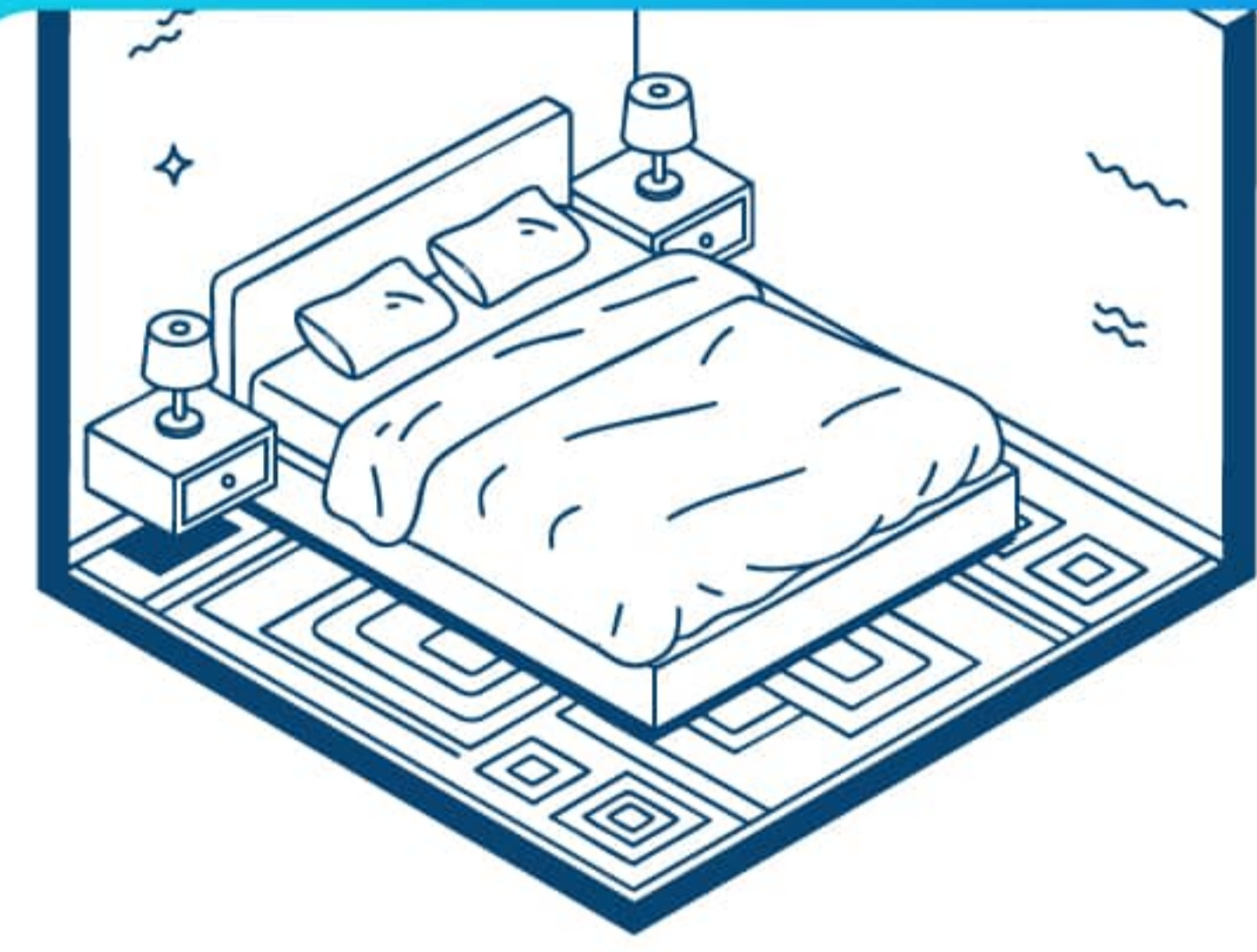

Middle Room



TERMS & Conditions

1. GUARDIANS FOR STUDENTS UNDER 12

Students under 12 must be accompanied by a guardian for trips and activities.

2. DEPOSIT PAYMENT

Deposit payment is compulsory and non-refundable after registration.

3. REGISTRATION DEADLINE

Registration must be completed at least 1 month before the program start date.

4. LANGKAWI TRIP

Limited seats available (first-come, first-served). In case of cancellation, RM 800 will be deducted.

5. FLIGHT TICKETS & ACCOMMODATION

Flight details must be provided at least 2 weeks in advance for airport pickup and accommodation arrangements.

6. CERTIFICATE OF COMPLETION

All students receive a certificate upon successful completion of the program.

7. CONSENT FOR STUDENTS UNDER 18

Parental consent is required for all students under 18.

8. AIRPORT TRANSFER

Airport transfer services are available during standard operating hours only. Flights arriving late at night or early in the morning may not be eligible for airport transfer.



come & join us